

EN3[®] SERIES WEATHERTIGHT CONNECTORS

NEW PRODUCT BULLETIN 602

SWITCHCRAFT[®]



Please visit www.switchcraft.com for the most up-to-date product specifications. Made in USA.

EN3® SERIES WEATHERTIGHT CONNECTORS

NEW PRODUCT BULLETIN 602



FEATURES & BENEFITS

- Sealed to IP68/IP69K NEMA 250 (6P)
- Patented grommet & o-ring free design
- Cable, panel & cable to cable options
- Gold plated contacts standard
- Solder, crimp & PC contact options
- Straight & right angle PC contact panel connectors

APPLICATIONS

- Any sealed data transmission
- Military or industrial GPS location devices
- Instrumentation
- Medical data carts
- Marine Applications
- Transportation
- General industrial electronic applications



Please visit www.switchcraft.com for the most up-to-date product specifications. Made in USA.

EN3® SERIES WEATHERTIGHT CONNECTORS

NEW PRODUCT BULLETIN 602

SPECIFICATIONS

MECHANICAL SPECIFICATIONS

Life:	Minimum 600 insertion / withdrawal cycles
Vibration:	Mil-Std 202 Method 201
Shock:	Mil-Std 202 Method 213B, condition K
Hex Nut Torque:	All series hex nut to withstand 8-10 in-lb tightening torque.
Coupling Locking Style	Bayonet with ribbed coupling nut (winged coupling nut optional)
Back Shell Style:	Boot

ELECTRICAL SPECIFICATIONS

Voltage Rating:	250 V AC/DC
Current Rating:	13.0 A – 2 or 3 #16 contacts accepts 16 through 18 AWG 7.5 A – 2 through 6 #20 contacts accepts 20 through 22 AWG 6.5 A – 7 or 8 #20 contacts accepts 20 through 22 AWG 3 A – 9 through 18 #26 contacts accepts 26 through 28 AWG
Insulation Resistance:	100 MΩ min
Contact Resistance:	20 mΩ max

ENVIRONMENTAL SPECIFICATIONS

Operating Temperature Rating:	-40°C to +65°C (-40°F to +149°F)
Moisture Resistance:	Mil-Std 202 Method 106F
Insulation Resistance:	Mil-Std 202 Method 302 condition B
Thermal Shock:	Mil-Std 202 Method 107G
Salt Atmosphere (Corrosion):	Mil-Std 202 Method 101D condition B
Weathertight:	IEC 60529 IP16/IP18 IEC 60529 IP66/IP68 IEC 60529 IP68/IP69K NEMA 250 (6P) CFR 46 Part 110.20

MATERIAL SPECIFICATIONS

Panel connector shells & locking disk:	Thermoplastic UL94V-0
Connector shell interior:	Elastomeric, Black UL 94HB
Contacts:	Copper Alloy, Gold over Nickel Plate

MOLDED CABLE ASSEMBLIES

Weathertight:	IEC 60529 IP66/IP68 IEC 60529 IP68 /IP69K NEMA 250 (6P) CFR 46 Part 110.20
---------------	---

CERTIFICATIONS

UL File E319753 ; 2-8 pin cord, in-line and panel only



Please visit www.switchcraft.com for the most up-to-date product specifications. Made in USA.

EN3® SERIES WEATHERTIGHT CONNECTORS

NEW PRODUCT BULLETIN 602

CORD CONNECTORS

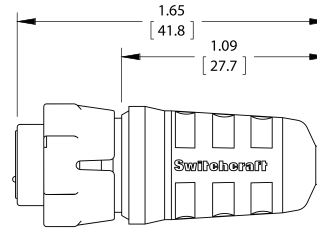
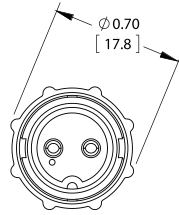

EN3 SERIES 2-18 POSITION
STANDARD
CABLE CLAMP & BOOT

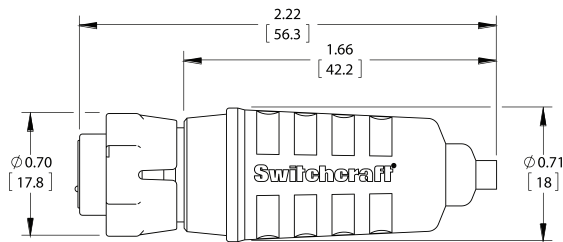

OPTION "L"
EN3 SERIES 2-18 POSITION
LARGE CABLE CLAMP & BOOT

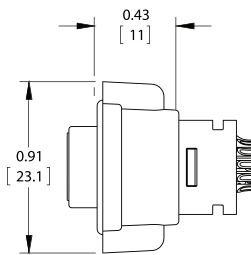

OPTION "W"
EN3 SERIES 2-18 POSITION
WINGED COUPLING RING

CABLE TO CABLE CONNECTORS

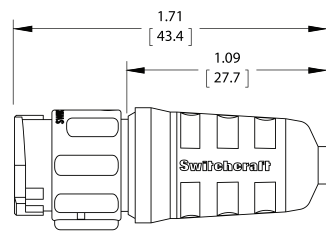
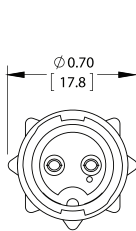

EN3 SERIES 2-18 POSITION
STANDARD
CABLE CLAMP & BOOT
INLINE CONNECTOR

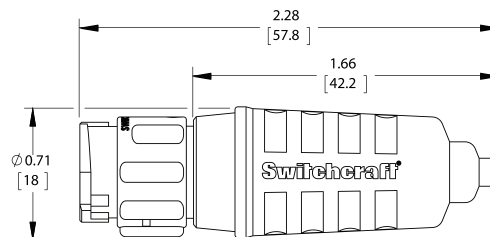

OPTION "L"
EN3 SERIES 2-18 POSITION
LARGE CABLE CLAMP & BOOT
INLINE CONNECTOR

EN3® RIGHT ANGLE 2-8 POSITION MOLDED CONNECTORS

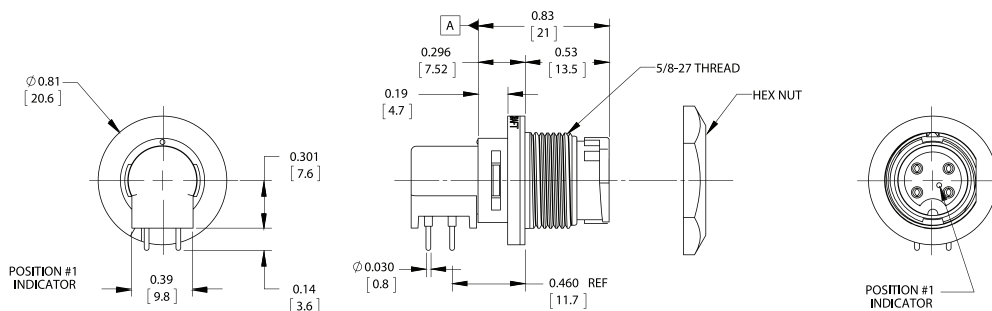

Please visit www.switchcraft.com for the most up-to-date product specifications. Made in USA.

EN3® SERIES WEATHERTIGHT CONNECTORS

NEW PRODUCT BULLETIN 602

PANEL CONNECTORS

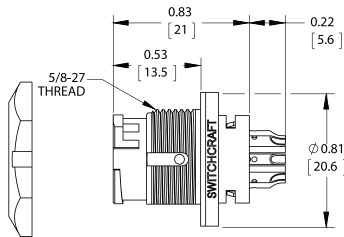

EN3 SERIES 2-8 POSITION
STANDARD SOLDER CUP
ALL POSITIONS FACE RADICALLY OUTWARD
EN3P8MX SHOWN

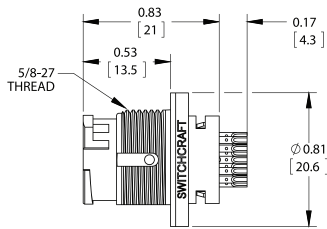

EN3 SERIES 9-18 POSITION
STANDARD SOLDER CUP
ALL POSITIONS FACE UPWARD
EN3P18M26X SHOWN

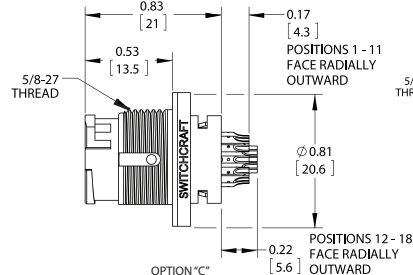

OPTION "C"
EN3 SERIES 2-8 POSITION
CRIMP TERMINALS
EN3P2M26CX SHOWN

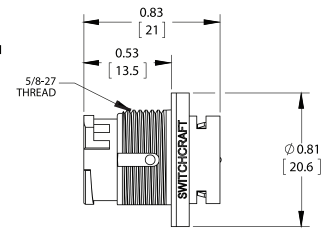

OPTION "S"
EN3 SERIES 9-18 POSITION ONLY
STANDARD SOLDER CUP
EN3P18M26SX SHOWN

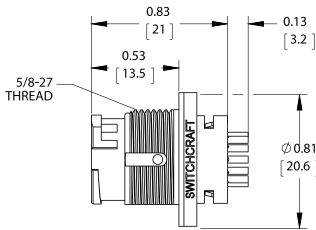

OPTION "C"
EN3 SERIES 9-18 POSITION
CRIMP TERMINALS
EN3P2M26CX SHOWN

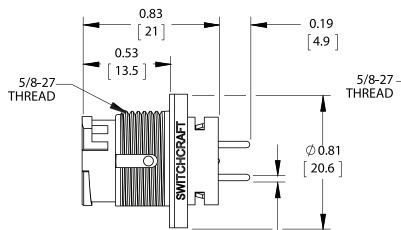

OPTION "P"
EN3 SERIES 2-8 POSITION
PC TERMINALS
EN3P2MPX SHOWN

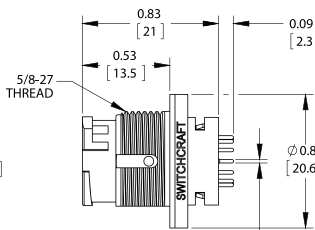

OPTION "P"
EN3 SERIES 9-18 POSITION
PC TERMINALS
EN3P9M26PX SHOWN

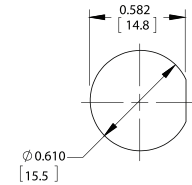

RECOMMENDED PANEL CUT-OUT
0.188 MAX PANEL THICKNESS ± 0.003 [0.08MM]
MOUNTING NUT
8-10 INCH-LBS MAX TORQUE

RIGHT ANGLE PC BOARDS 2-18 CONTACT PANEL CONNECTORS

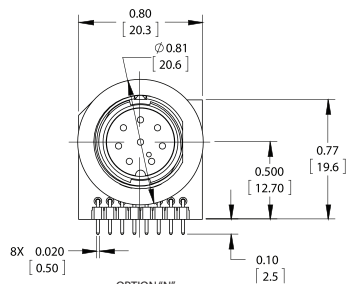

OPTION "N"
EN3 SERIES 2-8 POSITION
NARROW PCB
EN3P8MRAPCBN SHOWN
(NOT AVAILABLE IN FEMALE 7 & 8 POSITION)

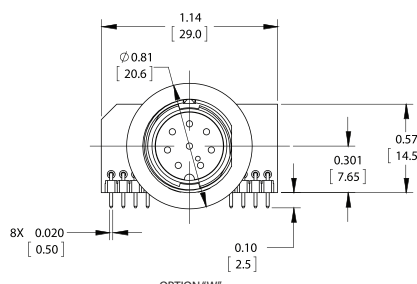

OPTION "W"
EN3 SERIES 2-8 POSITION
WIDE PCB
EN3P8MRAPCBW SHOWN
(NOT AVAILABLE IN FEMALE 7 & 8 POSITION)

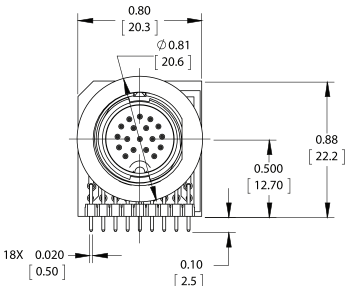
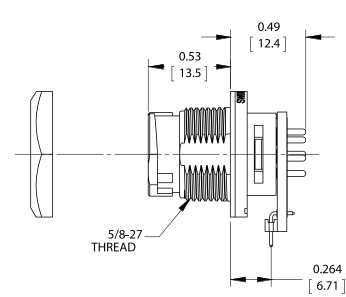

OPTION "N"
EN3 SERIES 9-18 POSITION
NARROW PCB
EN3P18MRAPCBN SHOWN

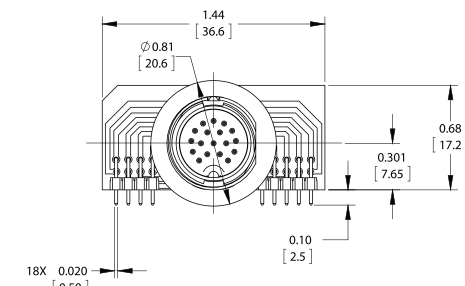

OPTION "W"
EN3 SERIES 9-18 POSITION
WIDE PCB
EN3P18MRAPCBW SHOWN

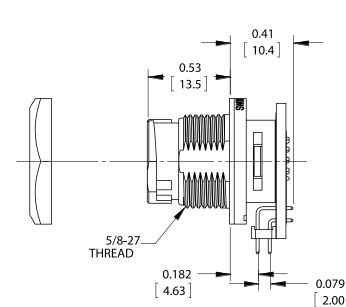

Please visit www.switchcraft.com for the most up-to-date product specifications. Made in USA.

EN3® SERIES WEATHERTIGHT CONNECTORS

NEW PRODUCT BULLETIN 602

EN3® ORDERING CODE

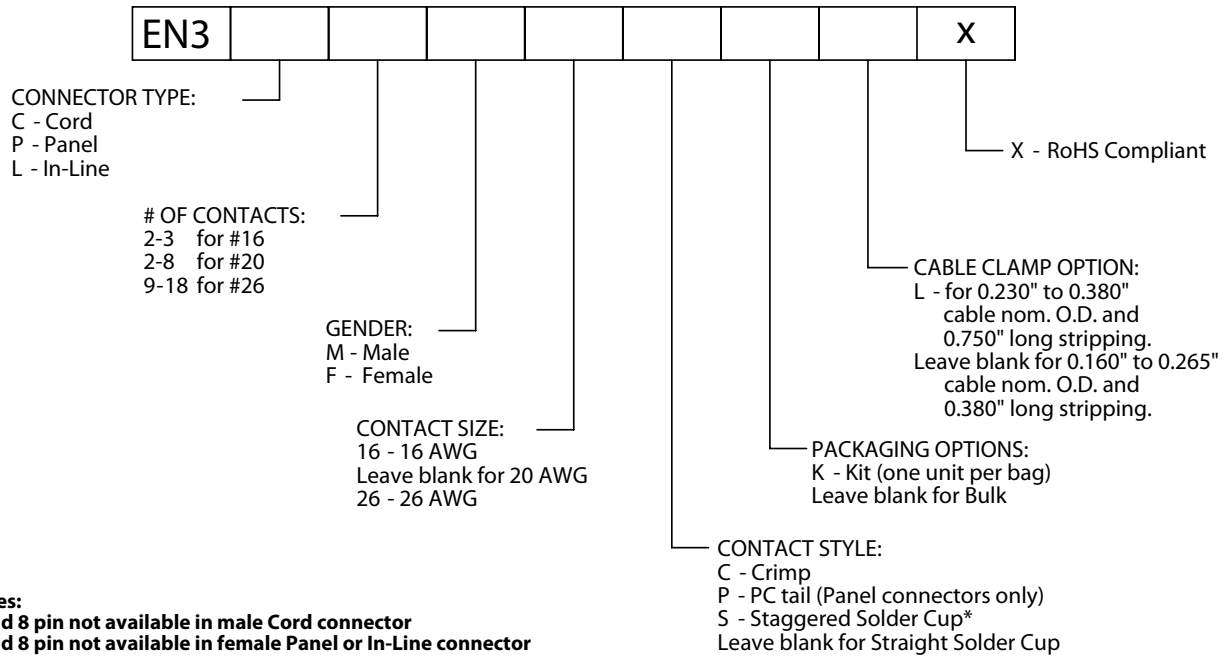

EN3® RIGHT ANGLE PC BOARD MOUNT 2-18 CONTACT ORDERING CODE

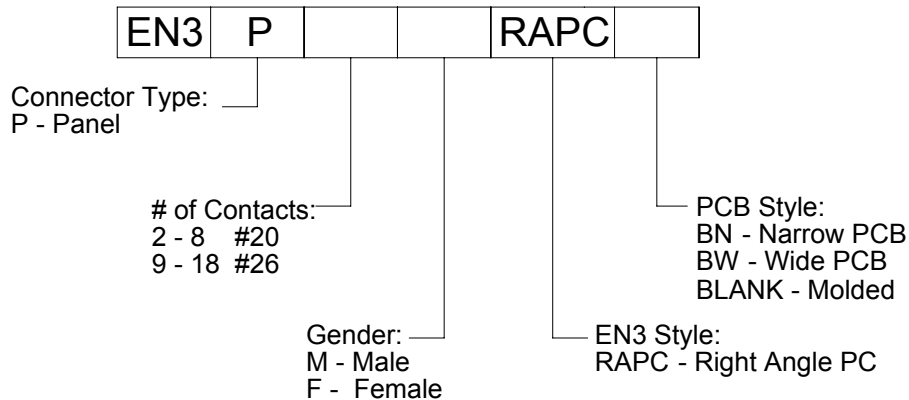

EN3® SERIES ACCESSORIES

<p>EN3 BOOT</p> <p>EN3 BOOTL</p> <p>EN3CAP</p> <p>EN3CAPC</p> <p>EN3CLAMPX</p> <p>EN3IPCAPX</p> <p>EN3NUT</p> <p>EN3PQCA</p>	<p>EN3 SERIES, REGULAR BOOT FOR CABLE DIAMETERS 0.160"-0.265"</p> <p>EN3 SERIES, LARGE BOOT FOR CABLE DIAMETERS 0.230"-0.380"</p> <p>EN3 HARSH ENVIRONMENT PANEL OR CABLE END CAP RATED TO IP68, RUBBER LANYARD STYLE</p> <p>CORD PLUG CAP FOR EN3 SERIES</p> <p>EN3 HARSH ENVIRONMENT CABLE CLAMP</p> <p>EN3 SERIES, IP68 RATED PANEL OR INLINE CAP WITH LOCK RING</p> <p>EN3 HARSH ENVIRONMENT HARDWARE-NUT</p> <p>EN3 PANEL ADAPTOR, FOR USE WITH EN3 QUICK CONNECT/ DISCONNECT CABLE ASSEMBLIES</p>
--	---



Please visit www.switchcraft.com for the most up-to-date product specifications. Made in USA.